

User Manual
SKU: ASX00031

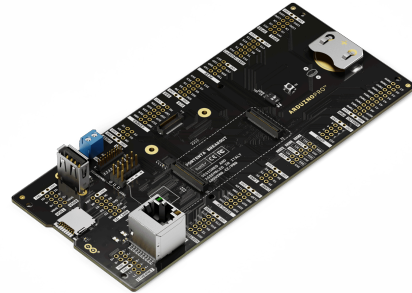

Description

The Arduino® Portenta Breakout board is designed to assist developers with their prototypes by exposing the high-density connectors of the Portenta family on both sides of the breakout carrier, providing total flexibility for measuring and controlling signals - developing your own hardware, testing the design and measuring the input and output signals out of the high-density connectors.

Target areas:

Prototyping

Features

- Power ON Button
- Boot mode DIP switch
- Connectors
 - USB-A
 - RJ45 Ethernet up to 1Gb/s; speed depending on installed board
 - Micro SD card
 - MIPI 20T JTAG with trace capability
- Power
 - CR2032 RTC Lithium Battery backup
 - External power terminal block
- I/O
 - Break out all Portenta high-density connector signals (see pinout table below)
 - Male/female HD connectors allow interposing breakout between Portenta and shield to debug signals
- Compatibility Standard Portenta high-density connector pinout
- Safety information Class A

Contents

1 The Board	5
1.1 Application Examples	5
1.2 Accessories (Not Included)	5
1.3 Related Products	5
1.4 Solution Overview	5
2 Ratings	6
2.1 Absolute Maximum Ratings	6
2.2 Recommended Operating Conditions	6
3 Functional Overview	6
3.1 Board Topology	6
3.2 DIP Switch	7
3.3 RJ-45 Connector	8
4 Board Operation	8
4.1 Getting Started - IDE	8
4.2 Getting Started - Arduino Cloud Editor	9
4.3 Getting Started - Arduino Cloud	9
4.4 Sample Sketches	9
4.5 Online Resources	9
4.6 Board Recovery	9
5 Connector Pinouts	9
5.1 GPIO	11
5.2 I2C	11
5.3 CAN0/CAN1	12
5.4 ANALOG/PWM	12
5.5 Display	13
5.6 UART1/UART0	13
5.7 SPI1/SPI0	13
5.8 PCIe	14
5.9 UART3/UART2	14
5.10 I2S/SAI	14
5.11 CAMERA: DCMI/CSI	15
5.12 PDM/SPDIF	15
5.13 J8 Power IN	15

6 Mechanical Information	16
6.1 Board Outline	16
7 Certifications	16
7.1 Declaration of Conformity CE DoC (EU)	16
7.2 Declaration of Conformity to EU RoHS & REACH 211 01/19/2021	17
7.3 Conflict Minerals Declaration	17
8 Company Information	18
9 Reference Documentation	18
10 Change Log	18

1 The Board

1.1 Application Examples

This product is designed to work alongside the Portenta family. Please check the Getting Started guide of your Portenta board.

Product Development: The Portenta Breakout board reduces development time for industrial-grade solution automation based on the Portenta line.

Technical Education: The Portenta Breakout board can act as a first point of entry for technician education in industrial-grade control and embedded systems.

1.2 Accessories (Not Included)

- 8-, 10-, 12- and 22-pin headers/connectors with 2.54 mm pitch
- 20 pin JTAG programmer

1.3 Related Products

- Arduino Portenta H7 (SKU: ABX00042)
- Arduino Portenta H7 Lite (SKU: ABX00045)
- Arduino Portenta H7 Lite Connected (SKU: ABX00046)
- Arduino Portenta X8 (SKU: ABX00049)

1.4 Solution Overview

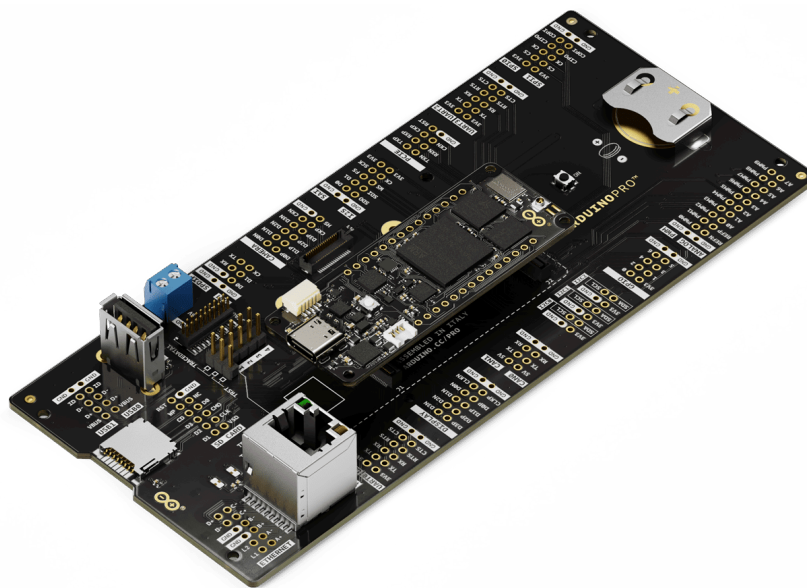

Example of a typical installation for a solution including Portenta H7. A Portenta board must be connected for operation of the Portenta Breakout Board.

2 Ratings

2.1 Absolute Maximum Ratings

Symbol	Description	Min	Typ	Max	Unit
T_{Max}	Maximum thermal limit	-40	20	85	°C
$5V_{Max}$	Maximum input voltage from 5V input	4.0	5	5.5	V
P_{Max}	Maximum Power Consumption	-	-	5000	mW

2.2 Recommended Operating Conditions

Symbol	Description	Min	Typ	Max	Unit
T	Conservative thermal limits	-15	20	60	°C
5V	Input voltage from 5V input	4.8	5	5.2	V

3 Functional Overview

3.1 Board Topology

Front view

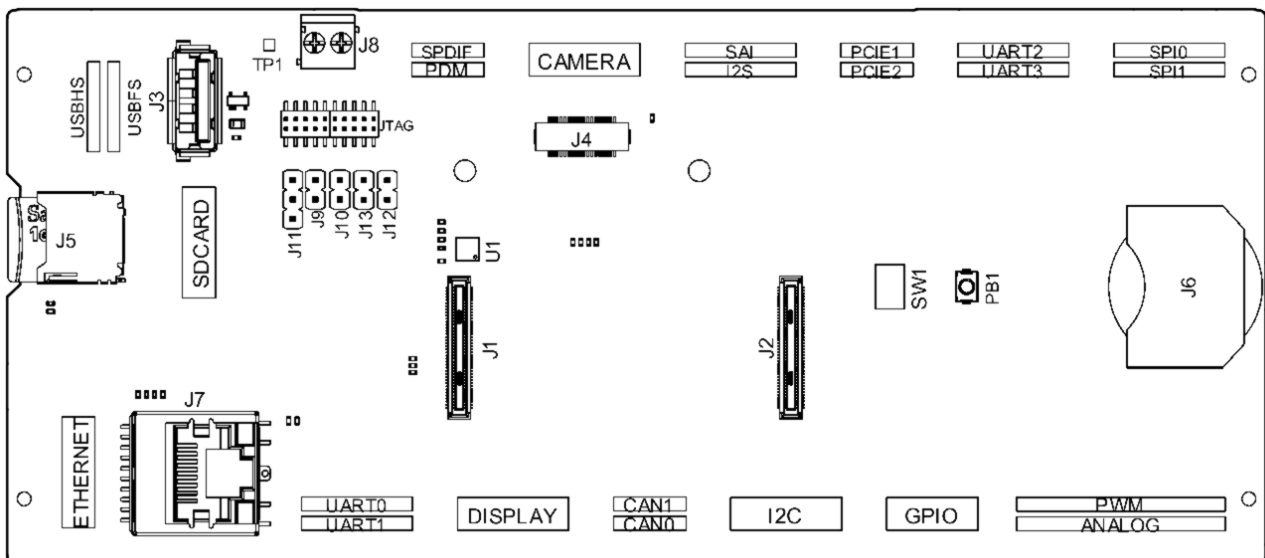

Top view - connectors

Ref.	Description	Ref.	Description
J1	DF40HC(3.5)-80DS-0.4V(51) High Density connector	J5	Micro SD card
J2	DF40HC(3.5)-80DS-0.4V(51) High Density connector	J6	20 mm coin battery retainer

Ref.	Description	Ref.	Description
J3	USB type A connector	J7	Ethernet adaptor
J4	Cam connector	J8	Power terminal block
SW1	Boot mode selection	PB1	Power ON button
U1	USBA power switch IC		

Back view

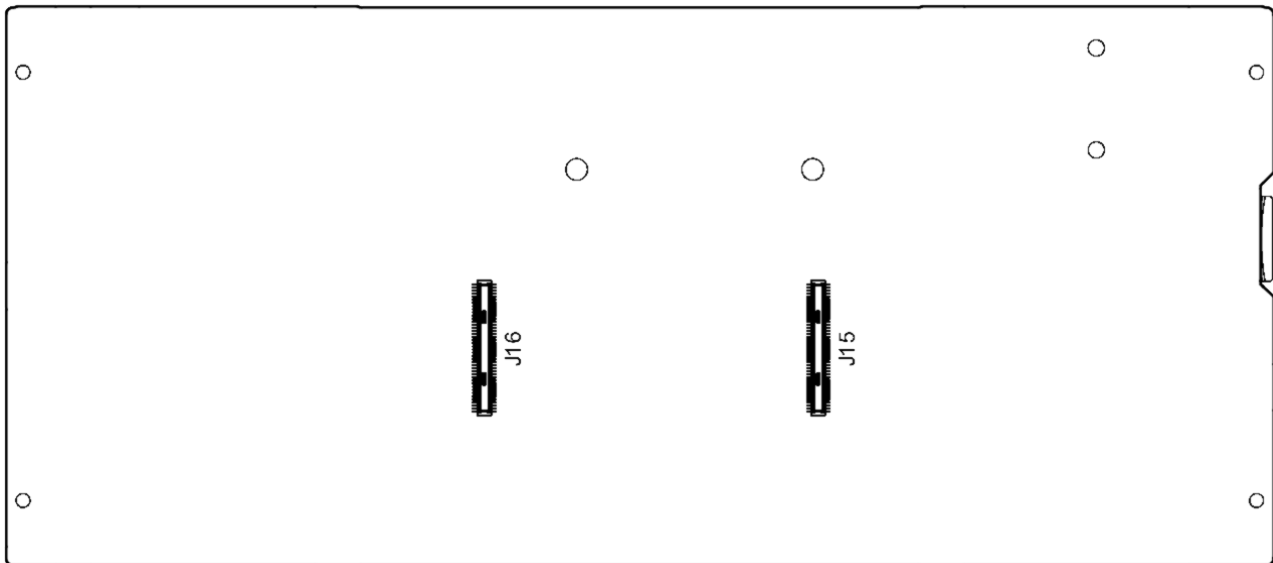

Bottom view - connectors

Ref.	Description	Ref.	Description
J15	DF40C-80DP-0.4V(51) High Density connector	J16	DF40C-80DP-0.4V(51) High Density connector

3.2 DIP Switch

The DIP switch allows for boot mode configuration:

- **BOOT SEL:** When set to ON, keeps the Portenta in Boot mode.
- **BOOT:** When set to ON enables the embedded bootloader. Firmware can be uploaded via the USB port on the breakout board (DFU). USB-A to USB-A (non-crossover) cable required. The Portenta H7 has to be powered through the USB-C® connector or VIN.

3.3 RJ-45 Connector

The RJ-45 Connector allows to plug in an ethernet cable and connect to your network.

By default it is compatible with the **Arduino Portenta H7** as the jumper pads are joint with copper.

To **allow** compatibility with the **Arduino Portenta X8** it is needed to cut 2 jumper pads, located on top of the the RJ-45 Connector, below the SD holder, on the left side of the Carrier as shown in the following picture.

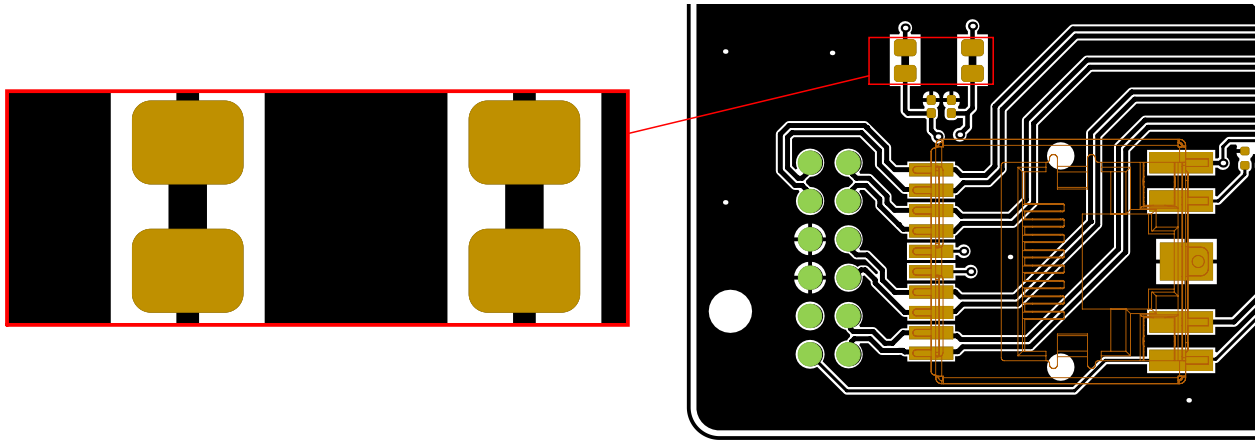

Ethernet Jumper pads

4 Board Operation

Note: This board is intended to operate together with Portenta H7 (see section 1.4 Solution Overview).

4.1 Getting Started - IDE

If you want to program your Portenta H7 with the Breakout Board while offline you need to install the Arduino Desktop IDE **[1]**. To connect your Portenta H7 with the Portenta Breakout Board to your computer, you will need a Type-C USB cable. This also provides power to both the Portenta H7 as well as the Portenta Breakout Board. Alternatively, in order to provide power to the USB connectors and the 5V pins, a 5V source must be applied to J8. This will also provide power to the Portenta H7.

4.2 Getting Started - Arduino Cloud Editor

All Arduino boards, including this one, work out-of-the-box on the Arduino Cloud Editor **[2]**, by just installing a simple plugin.

The Arduino Cloud Editor is hosted online, therefore it will always be up-to-date with the latest features and support for all boards. Follow **[3]** to start coding on the browser and upload your sketches onto your board.

4.3 Getting Started - Arduino Cloud

All Arduino IoT-enabled products are supported on Arduino Cloud which allows you to log, graph and analyze sensor data, trigger events, and automate your home or business.

4.4 Sample Sketches

Sample sketches can be found either in the “Examples” menu in the Arduino IDE or in the “Documentation” section of the Arduino Pro website **[4]**

4.5 Online Resources

Now that you have gone through the basics of what you can do with the board you can explore the endless possibilities it provides by checking exciting projects on ProjectHub **[5]**, the Arduino Library Reference **[6]** and the online store **[7]** where you will be able to complement your board with sensors, actuators and more

4.6 Board Recovery

In case a sketch locks up the processor and the board is not reachable anymore via USB it is possible to enter bootloader mode by double-tapping the reset button right after powering it up.

5 Connector Pinouts

The Portenta Breakout Board provides easy access to the pins on the high-density connector of the Portenta family. The Portenta Breakout Board is shipped in a headerless configuration to provide flexibility in using 2.54mm compatible connectors to meet their specific application.

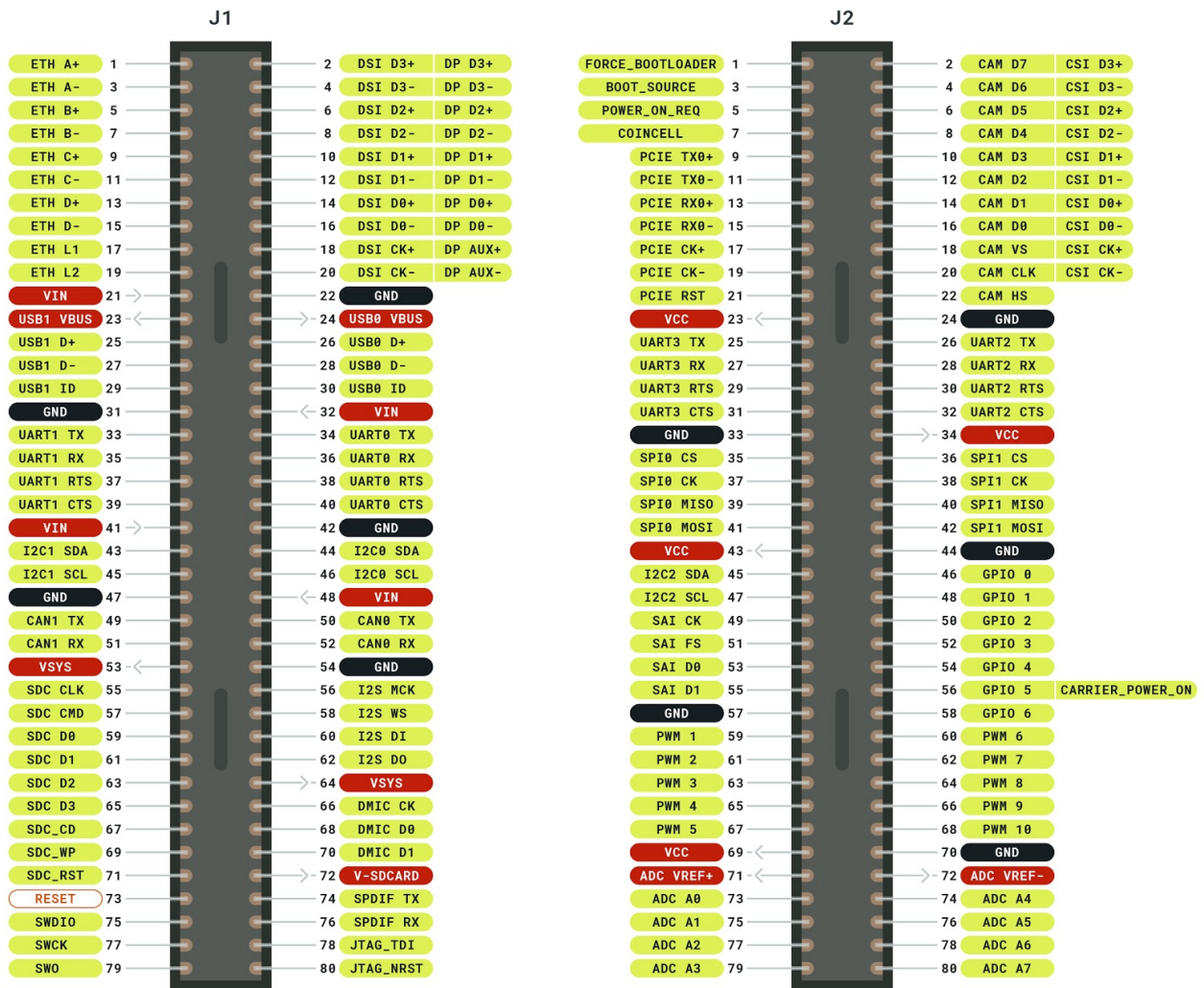

Pinouts

In cases where multiple channels are on a single header, the first channel is on the bottom part of the header and the section channel is on the top part of the header. The order of the channel is determined by the silkscreen markings.

5.1 GPIO

Pin	Function	Type	Description
1	3V3	Power	+3.3V power rail
2	GPIO 0	Digital	GPIO 0
3	GPIO 1	Digital	GPIO 1
4	GPIO 2	Digital	GPIO 2
5	GPIO 3	Digital	GPIO 3
6	GPIO 4	Digital	GPIO 4
7	GPIO 5	Digital	GPIO 5
8	GPIO 6	Digital	GPIO 6
9	GND	Power	Ground
10	GND	Power	Ground

5.2 I2C

Pin	Function	Type	Description
1	3V3	Power	+3.3V power rail
2	GND	Power	Ground
3	SDA1	Digital	Serial Data Line 1
4	SCL1	Digital	Serial Clock Line 1
5	3v3	Power	+3.3V power rail
6	GND	Power	Ground
7	SDA0	Digital	Serial Data Line 0
8	SCL0	Digital	Serial Clock Line 0
9	3V3	Power	+3.3V power rail
10	GND	Power	Ground
11	SDA2	Digital	Serial Data Line 2
12	SCL2	Digital	Serial Clock Line 2

5.3 CAN0/CAN1

Pins closer to the edge of the board are CAN0. Pins close to the center are CAN1. **Please Note** When used with Arduino Portenta H7, only CAN1 is available.

Pin	Function	Type	Description
1	5V	Power	+5.0V power rail
2	TX	Differential	CAN Bus Transmission Line
3	RX	Differential	CAN Bus Receive Line
4	GND	Power	Ground

5.4 ANALOG/PWM

Pin	Function	Type	Description
1	A0	Analog	Analog Input 0
2	A1	Analog	Analog Input 1
3	A2	Analog	Analog Input 2
4	A3	Analog	Analog Input 3
5	A4	Analog	Analog Input 4
6	A5	Analog	Analog Input 5
7	A6	Analog	Analog Input 6
8	A7	Analog	Analog Input 7
9	REFP	Analog	Analog Reference Positive
10	REFN	Analog	Analog Reference Negative
11	GND	Analog	Ground
1	PWM0	Digital	PWM output 0
2	PWM1	Digital	PWM output 1
3	PWM2	Digital	PWM output 2
4	PWM3	Digital	PWM output 3
5	PWM4	Digital	PWM output 4
6	PWM5	Digital	PWM output 5
7	PWM6	Digital	PWM output 6
8	PWM7	Digital	PWM output 7
9	PWM8	Digital	PWM output 8
10	PWM9	Digital	PWM output 9
11	GND	Digital	Ground

5.5 Display

Pin	Function	Type	Description
1	D3P	Differential	Differential DSI Data Line 3 Positive
2	D2P	Differential	Differential DSI Data Line 2 Positive
3	D1P	Differential	Differential DSI Data Line 1 Positive
4	D0P	Differential	Differential DSI Data Line 0 Positive
5	CLKP	Differential	Differential DSI Clock Positive
6	GND	Power	Ground
7	D3N	Differential	Differential DSI Data Line 3 Negative
8	D2N	Differential	Differential DSI Data Line 2 Negative
9	D1N	Differential	Differential DSI Data Line 1 Negative
10	D0N	Differential	Differential DSI Data Line 0 Negative
11	CLKN	Differential	Differential DSI Clock Negative
12	GND	Power	Ground

5.6 UART1/UART0

Pins closer to the edge of the board are UART1. Pins closer to the center are UART0.

Pin	Function	Type	Description
1	3V3	Power	+3.3 V power rail
2	TX	Digital	UART Transmission Signal
3	RX	Digital	UART Receive Signal
4	RTS	Digital	Request to send
5	CTS	Digital	Clear to send
6	GND	Power	Ground

5.7 SPI1/SPI0

Pins closer to the edge of the board are SPI0. Pins closer to the center are SPI1.

Pin	Function	Type	Description
1	3V3	Power	+3.3 V power rail
2	CS	Digital	Chip Select
3	CK	Digital	Serial Clock
4	MISO	Digital	Main In Secondary Out
5	MOSI	Digital	Main Out Secondary In
6	GND	Power	Ground

5.8 PCIe

Pin	Function	Type	Description
1	TXN	Differential	Differential PCIe Transmission Line Negative
2	RXN	Differential	Differential PCIe Receive Line Negative
3	CKN	Differential	Differential PCIe Clock Line Negative
4	GND	Power	Ground
1	TXP	Differential	Differential PCIe Transmission Line Positive
2	RXP	Differential	Differential PCIe Receive Line Positive
3	CKP	Differential	Differential PCIe Clock Line Positive
4	RST	Digital	Reset Signal

5.9 UART3/UART2

Pins closer to the edge of the board are UART2. Pins closer to the center are UART3.

Pin	Function	Type	Description
1	3V3	Power	+3.3 V power rail
2	TX	Digital	UART Transmission Signal
3	RX	Digital	UART Receive Signal
4	RTS	Digital	Request to send
5	CTS	Digital	Clear to send
6	GND	Power	Ground

5.10 I2S/SAI

Pin	Function	Type	Description
1	3V3	Power	+3.3 V power rail
2	CK	Digital	I2S Clock
3	WS	Digital	I2S Word Select
4	SD1	Digital	I2S Right Channel
5	SD0	Digital	I2S Left Channel
6	GND	Power	Ground
1	3V3	Power	+3.3 V power rail
2	SCK	Digital	SAI Clock
3	FS	Digital	SAI Frame Synchronization
4	D0	Digital	SAI Data Line 0
5	D1	Digital	SAI Data Line 1
6	GND	Power	Ground

5.11 CAMERA: DCMI/CSI

Pin	Function	Type	Description
1	GND	Power	Ground
2	HS	Digital	DCMI HSYNC
3	CKN	Digital	DCMI_CLK / CSI CKN
4	CKP	Digital	DCMI VSYNC / CSI CKP
5	D3N	Digital	DCMI D6 / CSI D3P
6	D3P	Digital	DCMI D7 / CSI D3P
7	D2N	Digital	DCMI D4 / CSI D2N
8	D2P	Digital	DCMI D5 / CSI D2P
9	D1N	Digital	DCMI D2 / CSI D1N
10	D1P	Digital	DCMI D3 / CSI D1P
11	D0N	Digital	DCMI D0 / CSI D0N
12	D0P	Digital	DCMI D1 / CSI D0P

5.12 PDM/SPDIF

Pin	Function	Type	Description
1	CK	Digital	PDM Clock
2	D0	Digital	PDM Data Line 0
3	D1	Digital	PDM Data Line 1
4	GND	Power	Ground
1	TX	Digital	SPDIF Transmission Signal
2	RX	Digital	SPDIF Receive Signal
3	GND	Power	Ground
4	GND	Power	Ground

5.13 J8 Power IN

Pin	Function	Type	Description
1	5V	Power	Supplies power to the CAN bus directly. VIN for the Portenta board and also provides the VUSB voltage through the NCP383
2	GND	Power	Ground

6 Mechanical Information

6.1 Board Outline

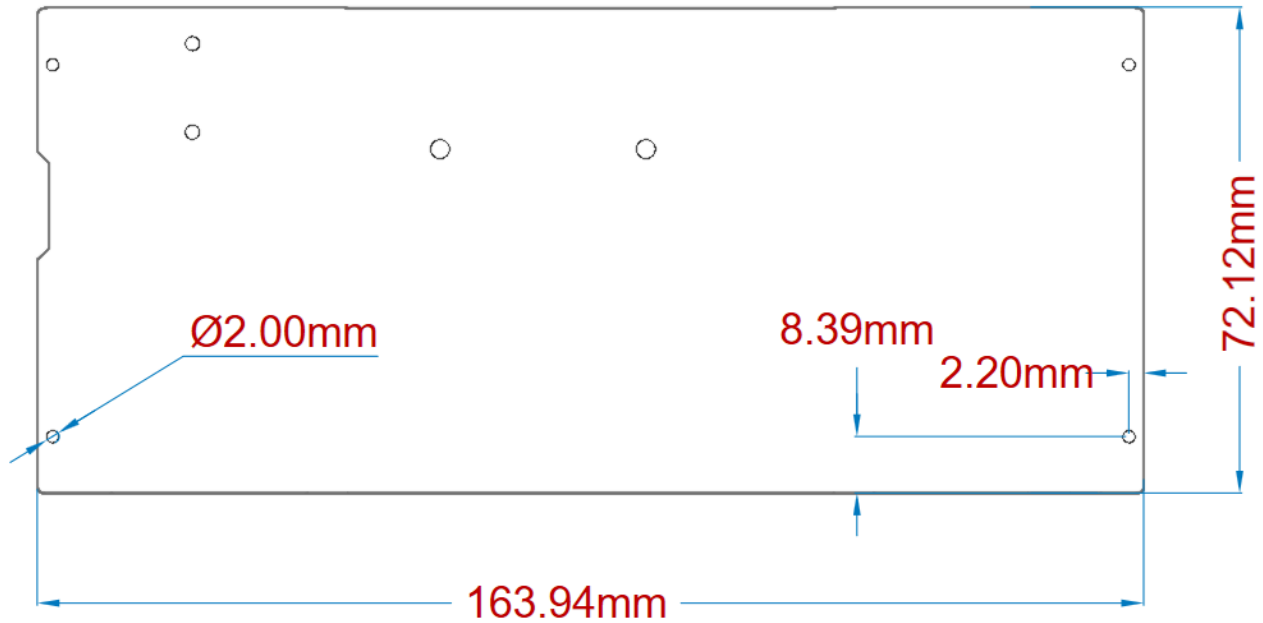

Board outline and screw holes

7 Certifications

7.1 Declaration of Conformity CE DoC (EU)

We declare under our sole responsibility that the products above are in conformity with the essential requirements of the following EU Directives and therefore qualify for free movement within markets comprising the European Union (EU) and European Economic Area (EEA).

7.2 Declaration of Conformity to EU RoHS & REACH 211 01/19/2021

Arduino boards are in compliance with RoHS 2 Directive 2011/65/EU of the European Parliament and RoHS 3 Directive 2015/863/EU of the Council of 4 June 2015 on the restriction of the use of certain hazardous substances in electrical and electronic equipment.

Substance	Maximum Limit (ppm)
Lead (Pb)	1000
Cadmium (Cd)	100
Mercury (Hg)	1000
Hexavalent Chromium (Cr6+)	1000
Poly Brominated Biphenyls (PBB)	1000
Poly Brominated Diphenyl ethers (PBDE)	1000
Bis(2-Ethylhexyl} phthalate (DEHP)	1000
Benzyl butyl phthalate (BBP)	1000
Dibutyl phthalate (DBP)	1000
Diisobutyl phthalate (DIBP)	1000

Exemptions : No exemptions are claimed.

Arduino Boards are fully compliant with the related requirements of European Union Regulation (EC) 1907 /2006 concerning the Registration, Evaluation, Authorization and Restriction of Chemicals (REACH). We declare none of the SVHCs (<https://echa.europa.eu/web/guest/candidate-list-table>), the Candidate List of Substances of Very High Concern for authorization currently released by ECHA, is present in all products (and also package) in quantities totaling in a concentration equal or above 0.1%. To the best of our knowledge, we also declare that our products do not contain any of the substances listed on the "Authorization List" (Annex XIV of the REACH regulations) and Substances of Very High Concern (SVHC) in any significant amounts as specified by the Annex XVII of Candidate list published by ECHA (European Chemical Agency) 1907 /2006/EC.

7.3 Conflict Minerals Declaration

As a global supplier of electronic and electrical components, Arduino is aware of our obligations with regards to laws and regulations regarding Conflict Minerals, specifically the Dodd-Frank Wall Street Reform and Consumer Protection Act, Section 1502. Arduino does not directly source or process conflict minerals such as Tin, Tantalum, Tungsten, or Gold. Conflict minerals are contained in our products in the form of solder, or as a component in metal alloys. As part of our reasonable due diligence Arduino has contacted component suppliers within our supply chain to verify their continued compliance with the regulations. Based on the information received thus far we declare that our products contain Conflict Minerals sourced from conflict-free areas.F

8 Company Information

Company name	Arduino S.r.l.
Company Address	Via Andrea Appiani, 25 - 20900 MONZA (Italy)

9 Reference Documentation

Ref	Link
Arduino IDE (Desktop)	https://www.arduino.cc/en/Main/Software
Arduino IDE (Cloud)	https://create.arduino.cc/editor
Cloud IDE Getting Started	https://create.arduino.cc/projecthub/Arduino_Genuino/getting-started-with-arduino-web-editor-4b3e4a
Arduino Pro Website	https://www.arduino.cc/pro
Project Hub	https://create.arduino.cc/projecthub?by=part&part_id=11332&sort=trending
Library Reference	https://www.arduino.cc/reference/en/
Online Store	https://store.arduino.cc/

10 Change Log

Date	Revision	Changes
03/09/2024	5	Cloud Editor updated from Web Editor
05/12/2023	4	Accessories section updated and small fixes
23/08/2022	3	Add RJ-45 jumpers information
14/12/2021	2	Clarified Camera compatibility
05/05/2021	1	First Release